



HUMAN TOUCH®  
**SUPER NOVO 3.0**  
MASSAGE CHAIR



human touch®

[humantouch.com](http://humantouch.com)

855.794.5660

©2026 Human Touch®, LLC. Patents and intellectual property rights enforced. No medical claims are warranted or implied by the use of this product. Human Touch is a trademark of Human Touch®, LLC. Sound by JBL and related logos are registered marks of HARMAN International Industries, Inc. and used under license.

HT-SuperNovo 3.0-ENG-A0



**use & care manual**

Register your product **ONLINE** Today

[www.humantouch.com/register](http://www.humantouch.com/register)

Register your product **ONLINE** Today

[www.humantouch.com/register](http://www.humantouch.com/register)



For **more than four decades**, Human Touch has established itself as an industry leader that is changing the lives of its customers with products and services that help them **feel, perform, and live their best**. Developed in cooperation with the medical community and industry experts, we deliver products that blend patented technology, craftsmanship and intelligent ergonomics with superior design to enable therapeutic relief for everyone.

Our industry-leading massage chairs, Perfect Chair® recliners and evolving set of innovative solutions share attributes in their ease-of-use, attention to performance and quality, and design to adapt to most any lifestyle. These attributes are highly valued by our customers and garner broad industry award and recognition. As a result, Human Touch empowers people to enjoy greater health and vitality in their professions, pursuits and everyday lives. And with a population increasingly aware of the benefits of wellness, Human Touch extends its brand leadership and available **solutions for the benefit of everyone**.

[humantouch.com](http://humantouch.com)

Proudly endorsed by:



Register your product at [www.humantouch.com](http://www.humantouch.com) to ensure your product is in our system to simplify the warranty process should you ever need it.

## HUMAN TOUCH® **SUPER NOVO 3.0** MASSAGE CHAIR

This is not a dream.

This is you **reaching your peak**.

Your mind at its sharpest.

Your body rejuvenated.

Your soul energized.

This is the **Human Touch Ascent Series**.

The Super Novo 3.0 captivates with its unibody construction, delivering three-dimensional massage along the entire length of your spine and all the way down to your thighs. Enjoy Meditation programs that combine a soothing soundtrack with your massage to help you focus your breathing and achieve a new, relaxed state of being. The programs in the Yoga Studio use deep stretching and pressure to loosen tight muscles and help relieve pain.

Allow yourself to be fully immersed in the enveloping melody of your favorite music by connecting to the built-in, premium Sound by JBL via Bluetooth, or play one of eight calming built-in Sound Soothe nature tracks and feel the stress simply melt away from your body. Download the intuitive Human Touch App to your Android or iOS device and suddenly your phone becomes an elegant controller for the chair.



**MORNING AND NIGHT, BOOKEND YOUR DAY WITH  
A HUMAN TOUCH ASCENT SERIES MASSAGE CHAIR  
AND UNLOCK YOUR FULL POTENTIAL.**

# keep it safe

## IMPORTANT SAFETY INSTRUCTIONS

When using an electrical appliance, basic precautions should always be followed, including the following:

### READ ALL INSTRUCTIONS BEFORE USING THIS APPLIANCE.

#### **DANGER:** To reduce the risk of electrical shock

Always unplug this product from the electrical outlet immediately after using and before cleaning.

#### **WARNING:** To reduce the risk of burns, fire, electric shock or injury to persons:

- Do not put hands or fingers near the massage mechanism or rollers while this product is running. Touching the mechanism can result in injury from the rollers squeezing together.
- If the supply cord is damaged, it must be replaced by the manufacturer or its service agent or a similarly qualified person in order to avoid a hazard.
- An appliance should never be left unattended when plugged in. Unplug from outlet when not in use, and before putting on or taking off parts.
- Do not operate under blanket or pillow. Excessive heating can occur and cause fire, electric shock, or injury to persons.
- Close supervision is necessary when this product is used by, on, or near children, invalids, or disabled persons. Keep children away from extended foot support (or other similar parts).
- Use this product only for its intended use as described in this manual. Do not use attachments not recommended by the manufacturer.
- Never operate this product if it has a damaged cord or plug, if it is not working properly, if it has been dropped or damaged, or dropped into water. Return this product to a service center for examination and repair.
- Do not carry this appliance by supply cord or use cord as a handle.
- Always keep the power cord away from heated surfaces.
- Never operate this product with the air openings blocked. Keep the air openings free of lint, hair, and the like.
- Never drop or insert any object into any opening.
- Do not use outdoors.
- Do not operate where aerosol (spray) products are being used or where oxygen is being administered.
- To disconnect, turn all controls to the OFF position, then remove plug from outlet.
- Do not massage any area of the body that is swollen, inflamed or covered with skin eruptions.
- Do not use on unexplained calf pain.
- Do not use this product when standing on a damp floor, or when any part of the body is in contact with plumbing or any similar ground.
- Connect this appliance to a properly grounded outlet only. See **GROUNDING INSTRUCTIONS**.
- Do not use this product if noise above normal sound is heard.
- Do not stand on or in appliance. Use only while seated.
- This appliance is not intended for use by persons (including children) with reduced physical, sensory or mental capabilities, or lack of experience and knowledge, unless they have been given supervision or instruction concerning use of the appliance by a person responsible for their safety. Children should be supervised to ensure that they do not play with the appliance.

### SAFETY PRECAUTIONS

- Comfortable clothing is recommended while using this product.
- This product was meant to be used in a relaxed position. Never force any body part into the backrest area while the rollers are moving.
- If you feel any abnormal discomfort during the operation of this product, turn off the power immediately and do not use the product. Consult your physician.
- Do not sit on the controller.
- Do not pull on the AC cord.
- When using this product after it has been in storage, check to see that the product is operating properly prior to use.
- Always confirm that there are no obstacles behind the product and that there is sufficient space to recline.

### SAVE THESE INSTRUCTIONS

**Do not attempt to repair this product yourself.**

This product is designed for personal in-home use. Commercial use will void warranty.

### Grounding Instructions:

This product must be grounded. If it should malfunction or breakdown, grounding provides a path of least resistance for electrical current to reduce the risk of electric shock. This product is equipped with a cord having an equipment grounding conductor and a grounding plug. The plug must be plugged into an appropriate outlet that is properly installed and grounded in accordance with all local codes and ordinances.

**DANGER:** Improper connection of the equipment-grounding conductor can result in a risk of electronic shock. Check with a qualified electrician or serviceman if you are in doubt as to whether this product is properly grounded. Do not modify the plug provided with the product – if it will not fit the outlet, have a proper outlet installed by a qualified electrician.

This product is for use on a nominal 120 V circuit and has a ground plug that looks like the plug illustrated in Sketch A. Make sure that the product is connected to an outlet having the same configuration as the plug. No adapter should be used with this product.

### For all grounded cord-connected products:

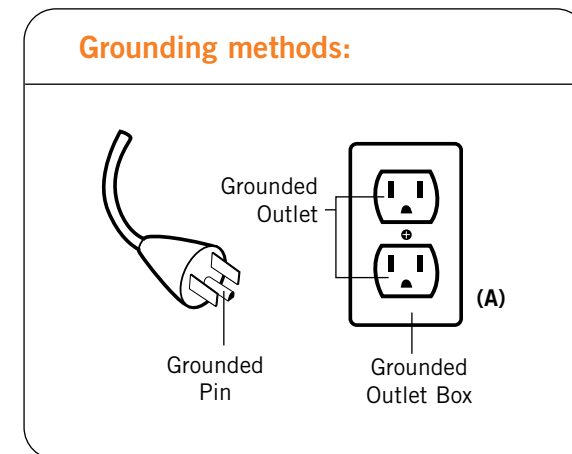

### Earthing:

This massage chair is a Level 1 electrical appliance. Make sure to use a three-prong power supply and to guarantee the grounded pin is fully inserted into a grounded outlet box to avoid electrical leakage, electrical shock, and other potential negative effects while in use.



This device complies with Part 15 of the FCC Rules. Operation is subject to the following two conditions: (1) This device may not cause harmful interference, and (2) this device must accept any interference received, including interference that may cause undesired operation.

**WARNING:** This product is equipped with a thermal resetting protection device. This is an added safety feature to protect you and this product from overheating. If the product should suddenly stop and will not start, turn the main power switch, located on the back of the product, off and do not operate the product for at least 30 minutes. Failure to turn the product off may result in the product starting unexpectedly when the device cools.

# get ready

Assembling your massage chair is easy! Simply plug in the power cord and you're set to go!

## UNPACK THE BOX

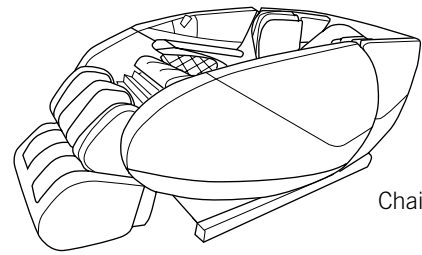

Chair

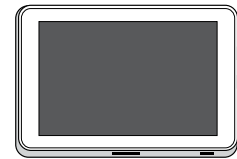

Tablet Controller

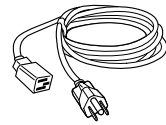

Power cord

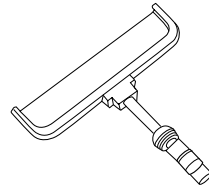

Tablet Stand

## CHOOSE A LOCATION

When deciding where to place your Super Novo 3.0, consider the following:

- Place the unit on a flat surface, away from direct sunlight (to avoid fading) or any other direct heat source.
- If you wish to place the unit on a hard surface, it is recommended that you place a piece of carpet or a soft mat underneath it to avoid damaging the floor (minimum 48" x 28").
- To accommodate the footrest when deployed, make sure the area in front of the chair is clear for at least 24".
- To ensure the chair does not hit the wall when reclining, make sure there is a 8" clearance behind it.

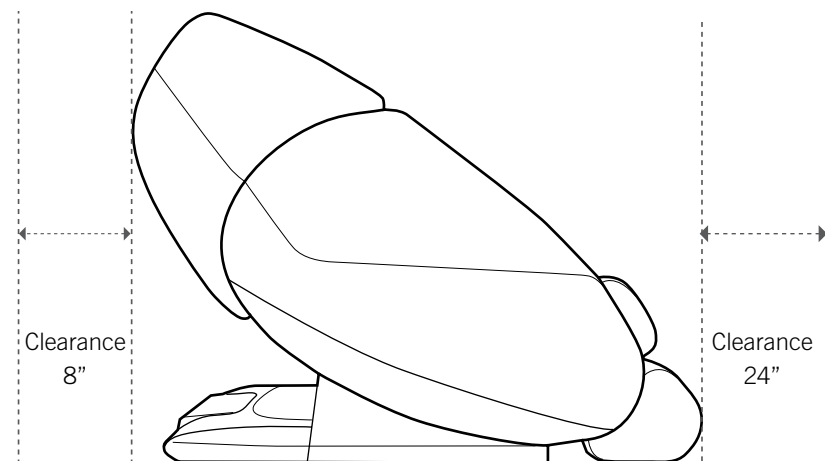

## PLUG IN THE CHAIR AND POWER IT ON

1. Plug the power cord into a grounded 120-volt outlet.
2. Connect the power cord to the power plug on the rear of the chair and switch the chair to ON ( I ) via the power switch.
3. The chair will restore to an upright position once powered ON.
4. When upright and restored, power OFF ( O ) chair

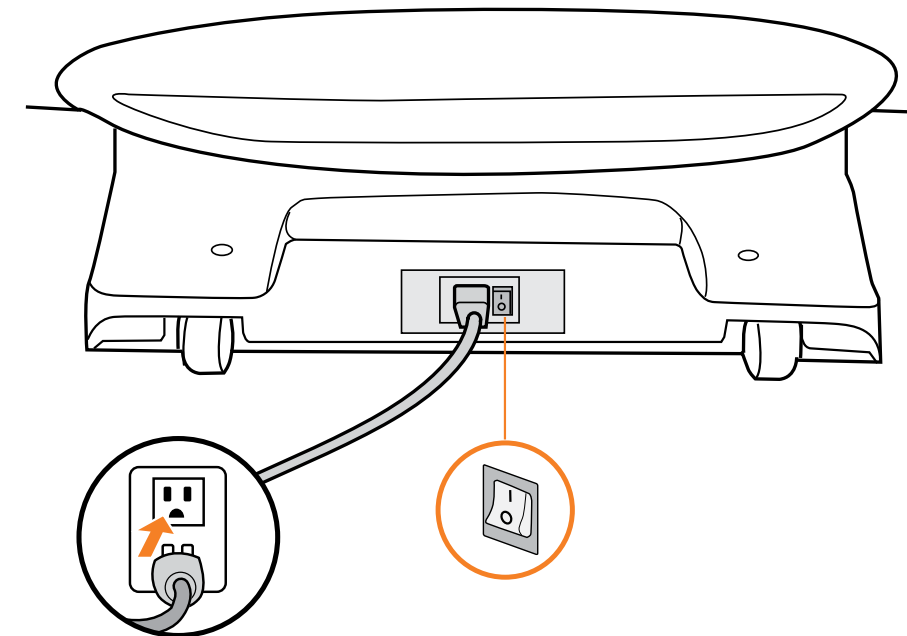

(Fig.1)

## MOVE THE CHAIR TO THE DESIRED LOCATION

**CAUTION:** To avoid injury to yourself and damage to the product, use two or more people to move the chair.

1. **Person 1:** Grasp the headrest, near the speakers (Fig.2).

**Person 2:** Grasp each side of the chair base, near the footrest (Fig.2).

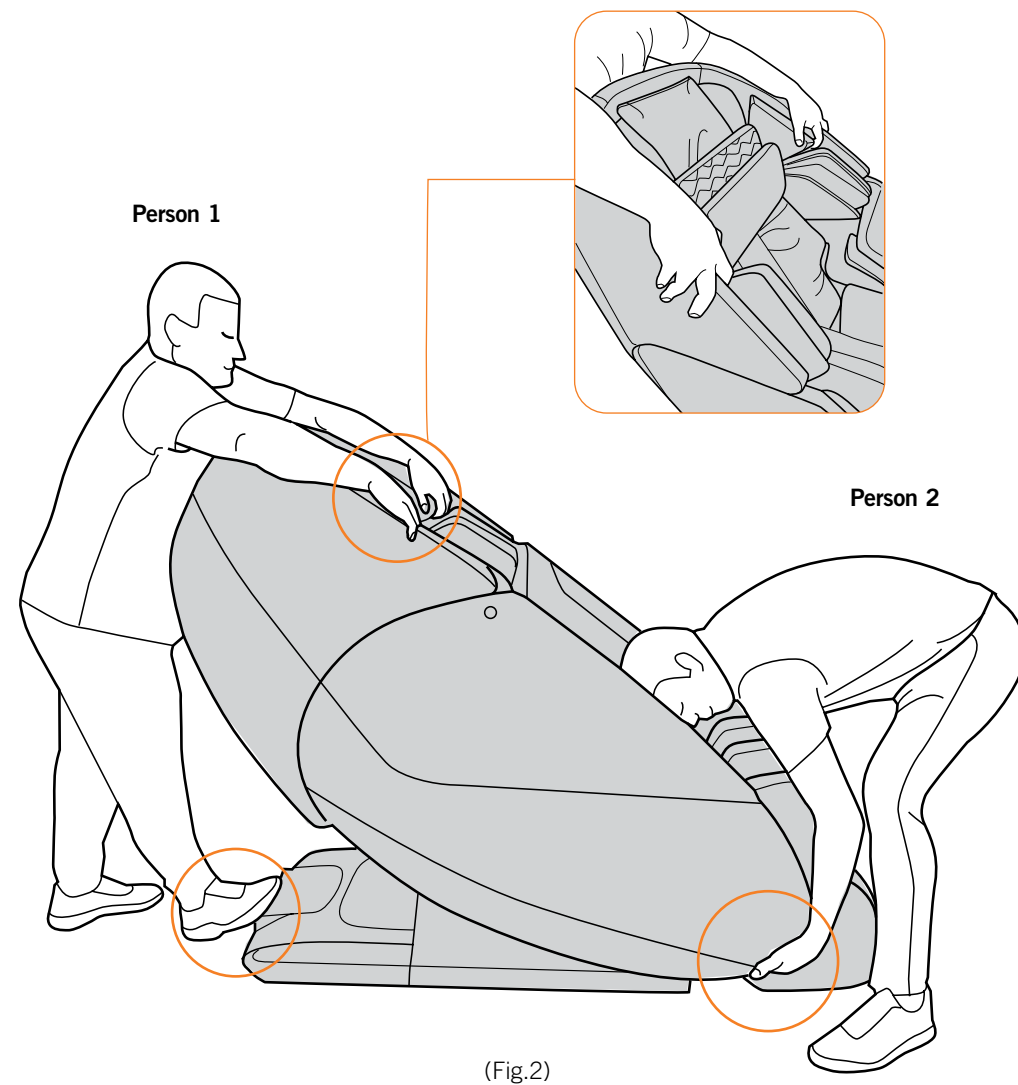

2. **Person 1:** Push downward on the headrest to rotate the chair onto its mobility wheels (Fig.3).

**Person 2:** Lift the front of the chair (Fig.3).

3. Roll the chair on its mobility wheels to the desired location.

4. Gently lower the chair to the floor.

**WARNING:** Dropping the front of the chair to the floor may damage the chair and/or floor.

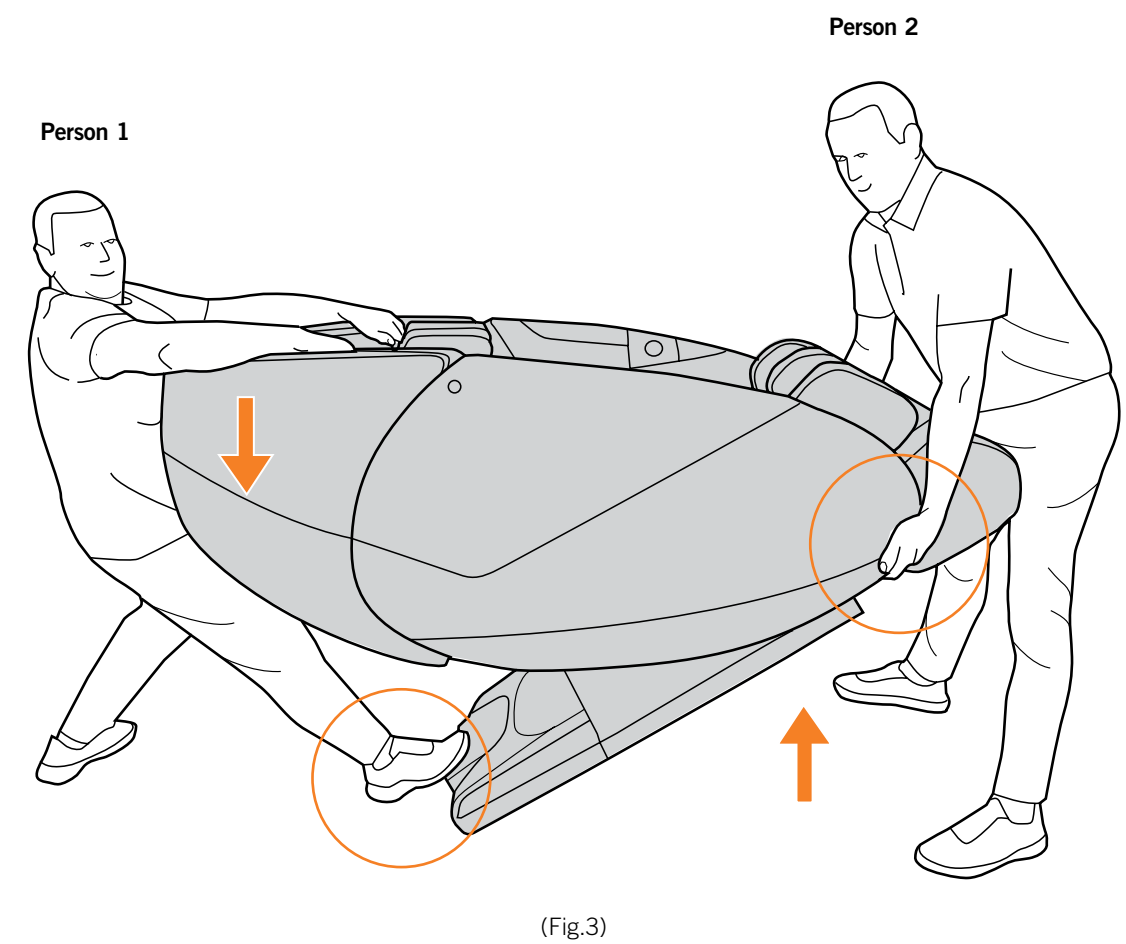

## ASSEMBLE THE PARTS

1. With the chair in desired location, ensure the chair is powered OFF (O).
2. Attach the tablet stand by inserting it into the control panel socket and turn clockwise to finger-tighten the collar ring (Fig.4).

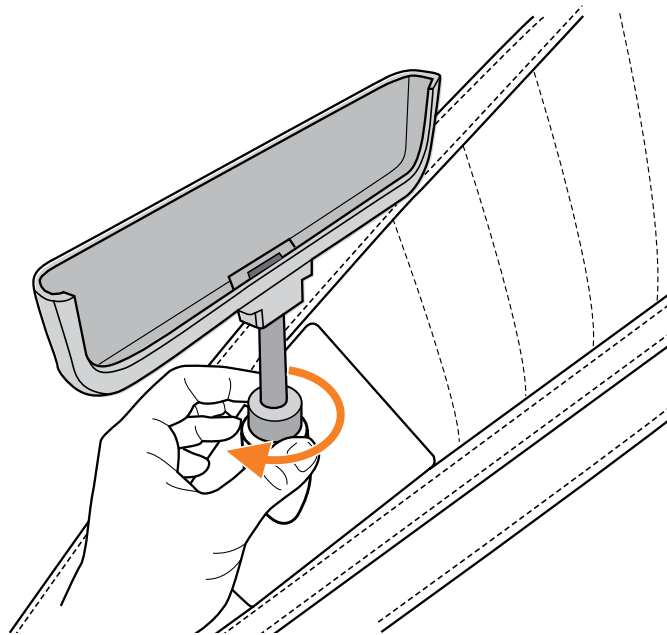
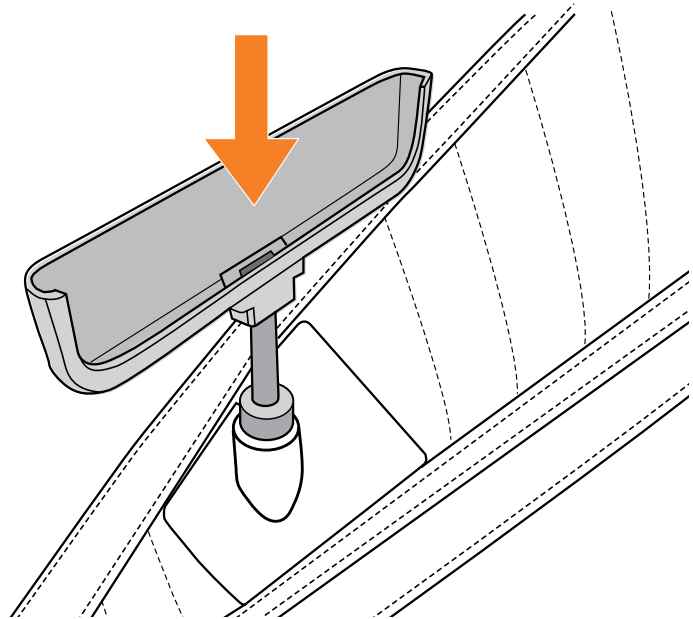

(Fig.4)

3. Place the tablet controller in the tablet stand (Fig.5).

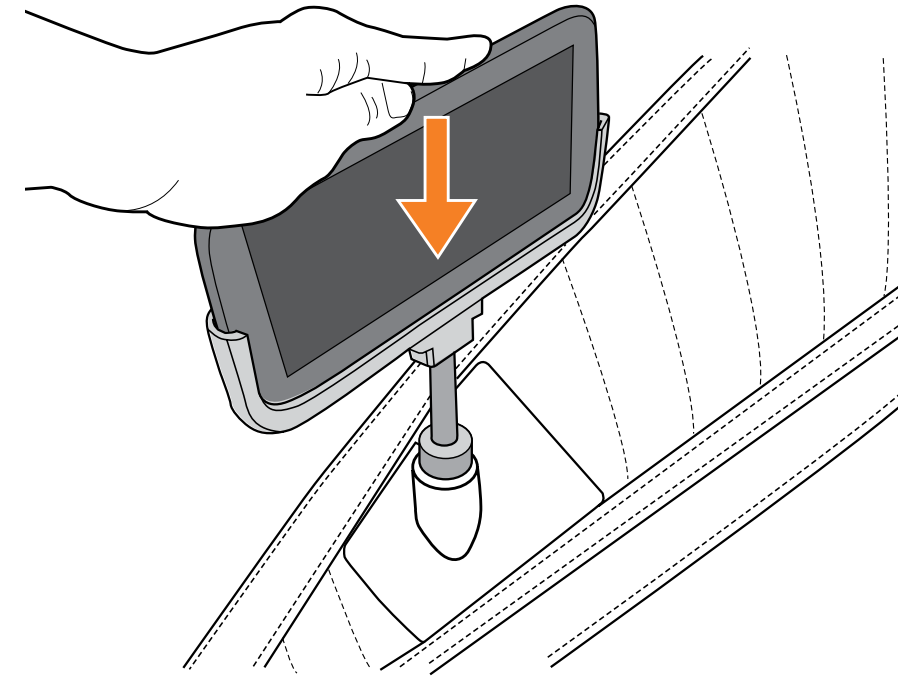

(Fig.5)

**NOTE:** Press the tablet firmly into the stand to ensure charging pins are connected.

# get acquainted

## NAVIGATING THE CHAIR

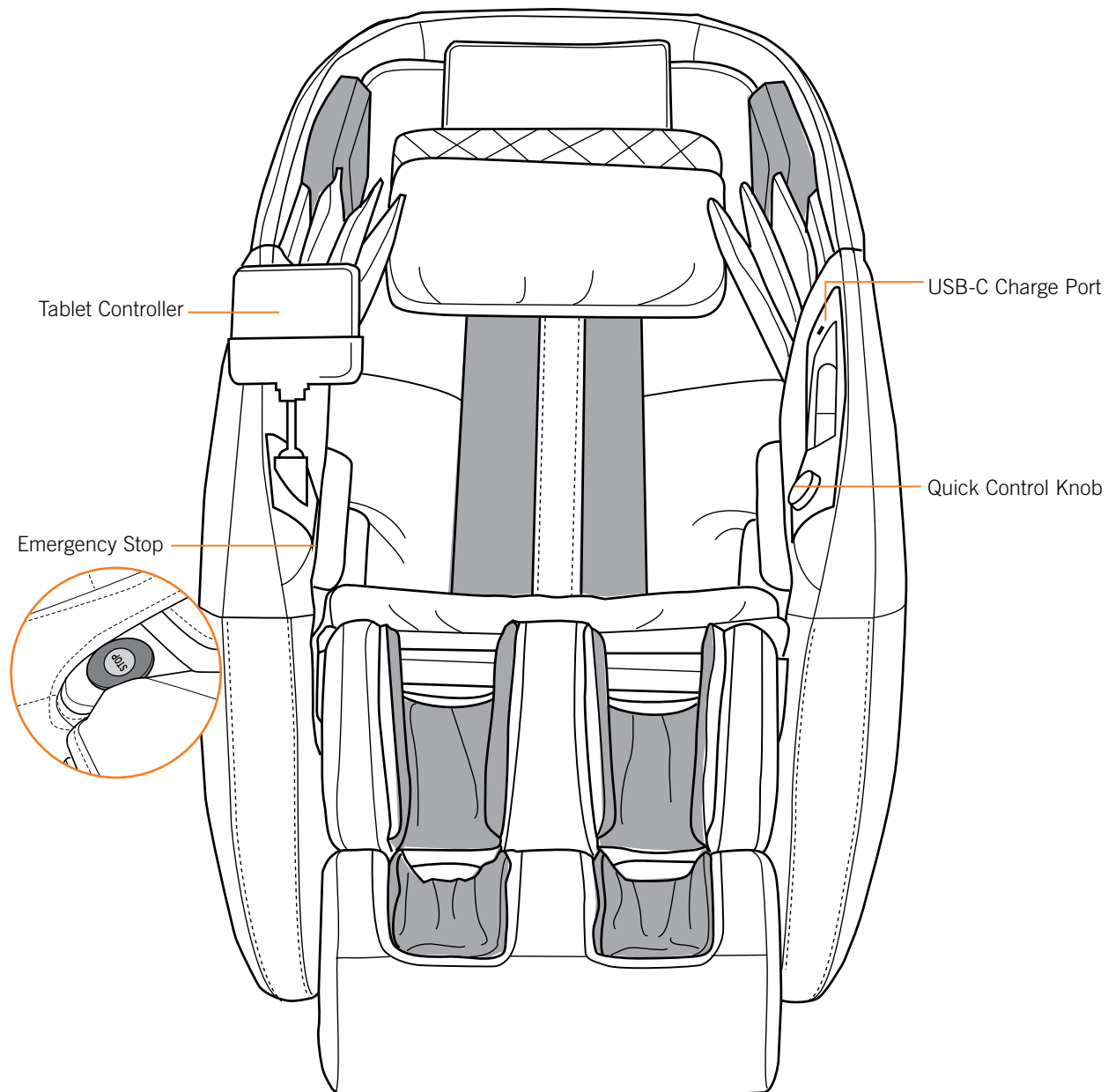

## USING THE TABLET CONTROLLER



## USING THE QUICK CONTROL KNOB

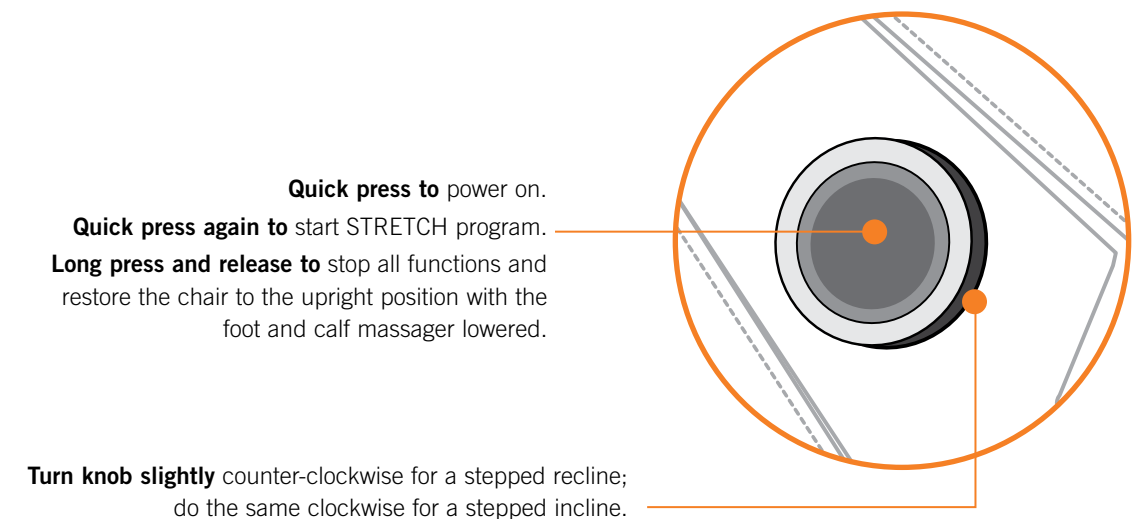

# get started

## CONNECT THE TABLET CONTROLLER

To pair the tablet controller for the first time (or after an extended power shut-off event):

1. Power on the tablet by pressing and holding the tablet power button on the right-hand side of the tablet.

**Note:** You may need to hold down the tablet power button for 7-10 seconds

2. Select the 'CONNECT' button or navigate to 'Tablet Control Connection' in the Settings menu.
3. Select the chair serial number that matches the serial number on the back of the chair base.

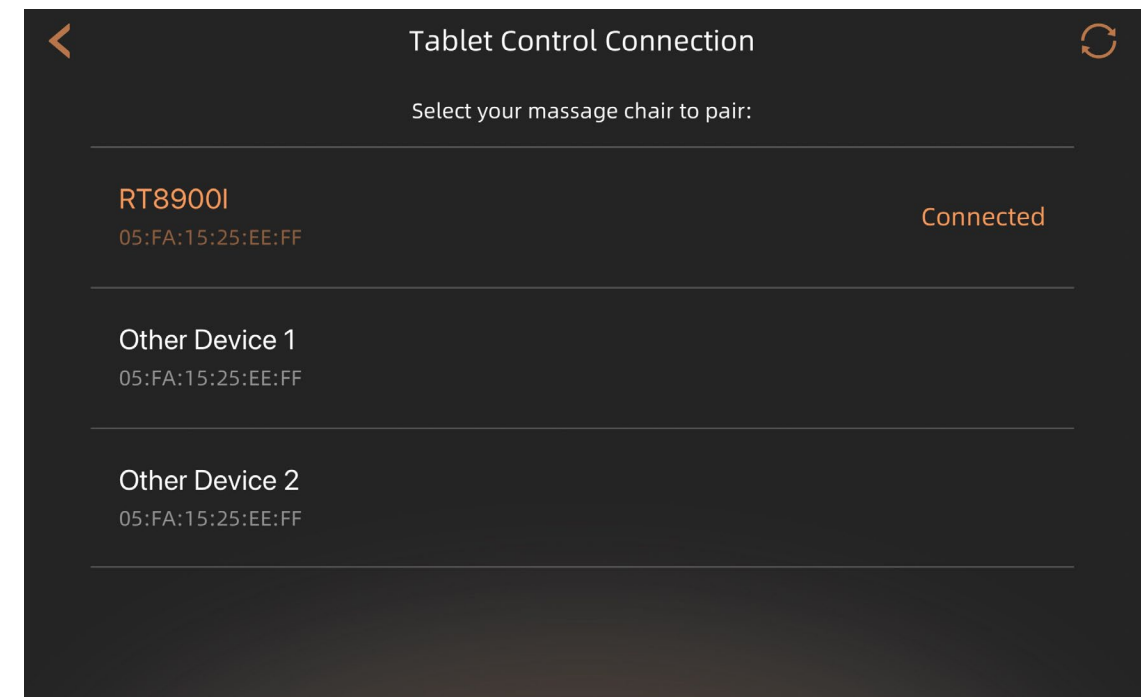
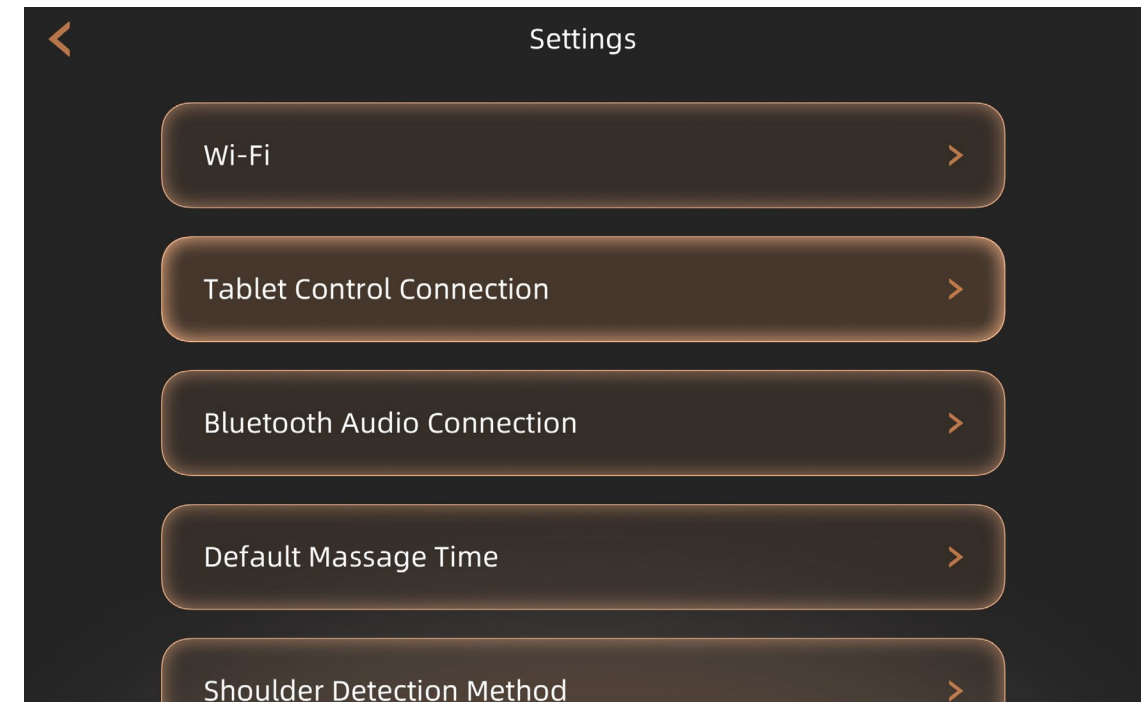
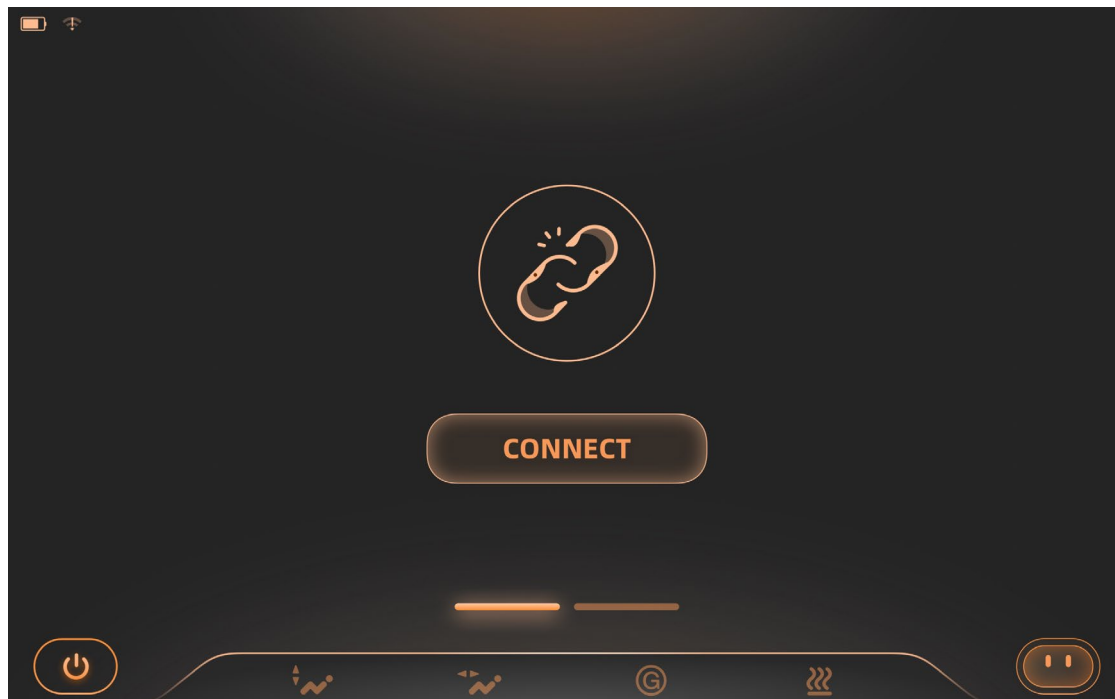

## NAVIGATING THE MAIN MENU



**Note:** Some features require a stable Wi-Fi connection and the latest software version to function as intended.

# take it easy

## USING THE AUTO PROGRAMS

**Swipe** left or right to navigate through the Featured, Yoga Studio, 4D and Meditation, and Core Auto Programs, then select a massage to get started.

**Tip:** You may also navigate through the Program categories by using the arrows on either side of the screen or selecting the category name.

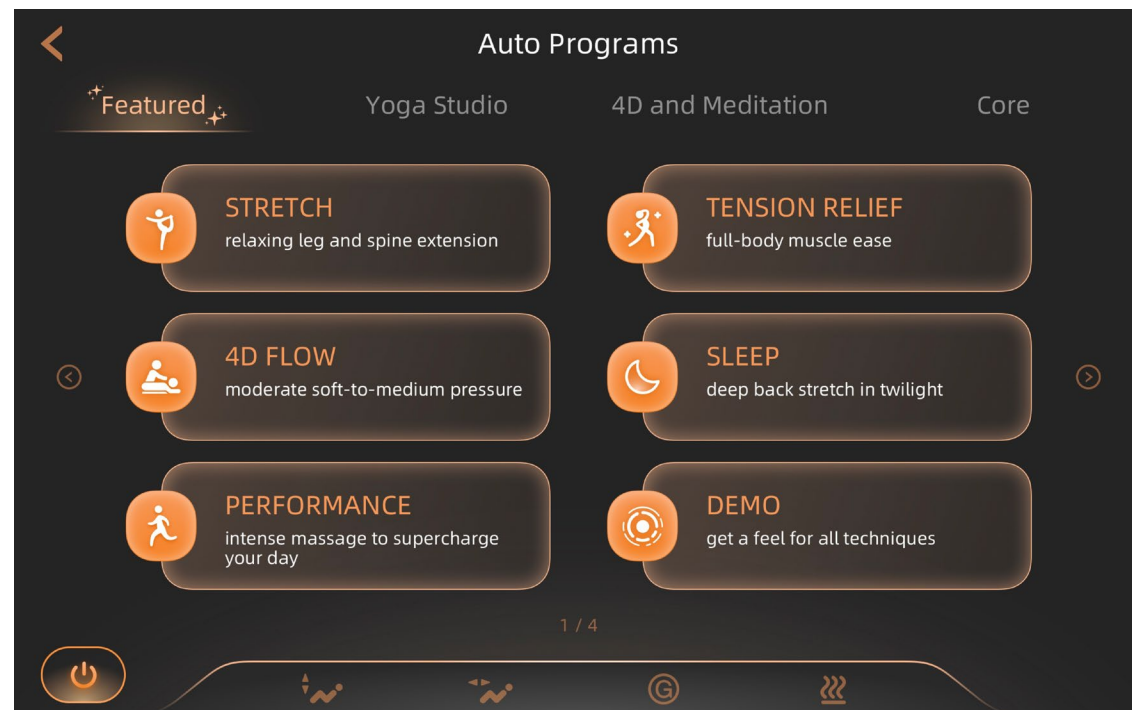

## USING THE AI PROGRAMS

**Note:** Chair must be connected to a Wi-Fi network to activate the AI feature. Go to Settings > Wi-Fi to connect to an available network.

Select from a popular prompt or press and hold the **Hold to Talk** button to share how your body is feeling, then release when finished. You may also select the keyboard icon to type your request.

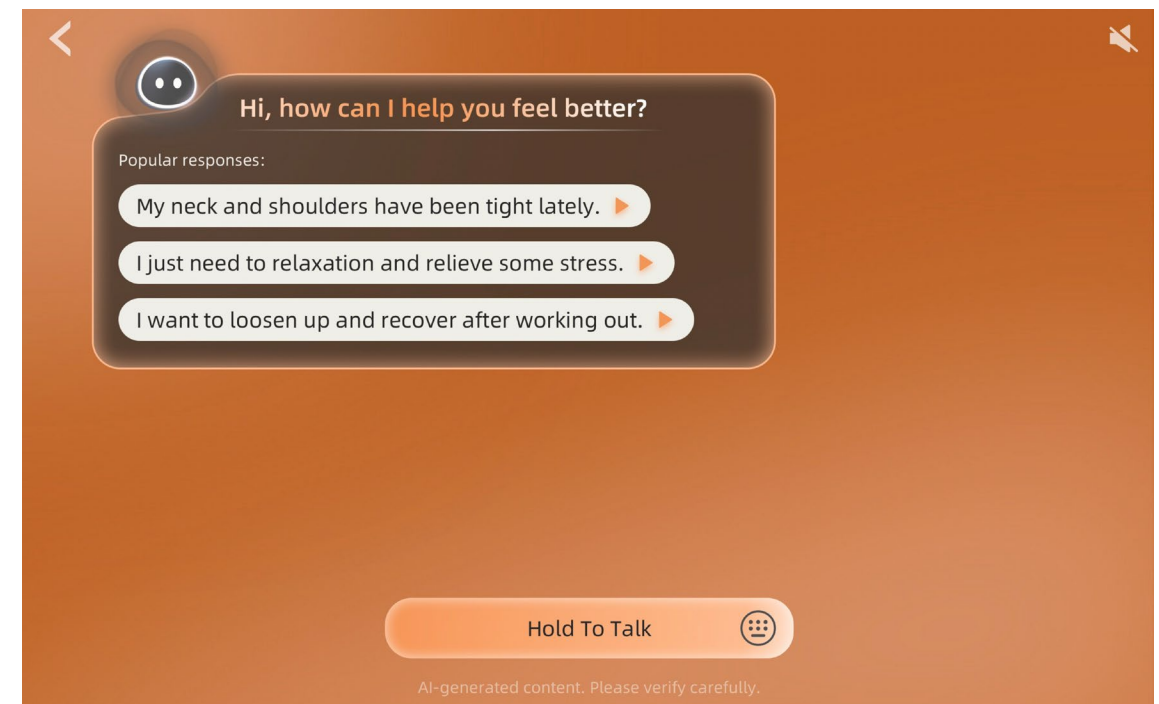

**Note:** AI Programs require a stable Wi-Fi connection and the latest software version to function as intended.

## CONTROL YOUR MASSAGE

Select a **menu** option to explore other massage programs, get more specific with your massage, or enhance your existing session.

Rescan or adjust your **shoulder height** for an optimal massage experience.

**Note:** Default setting is Auto using AcuPoint® Body Sensing technology. To change setting to Manual, navigate to Settings > Shoulder Detection Method.

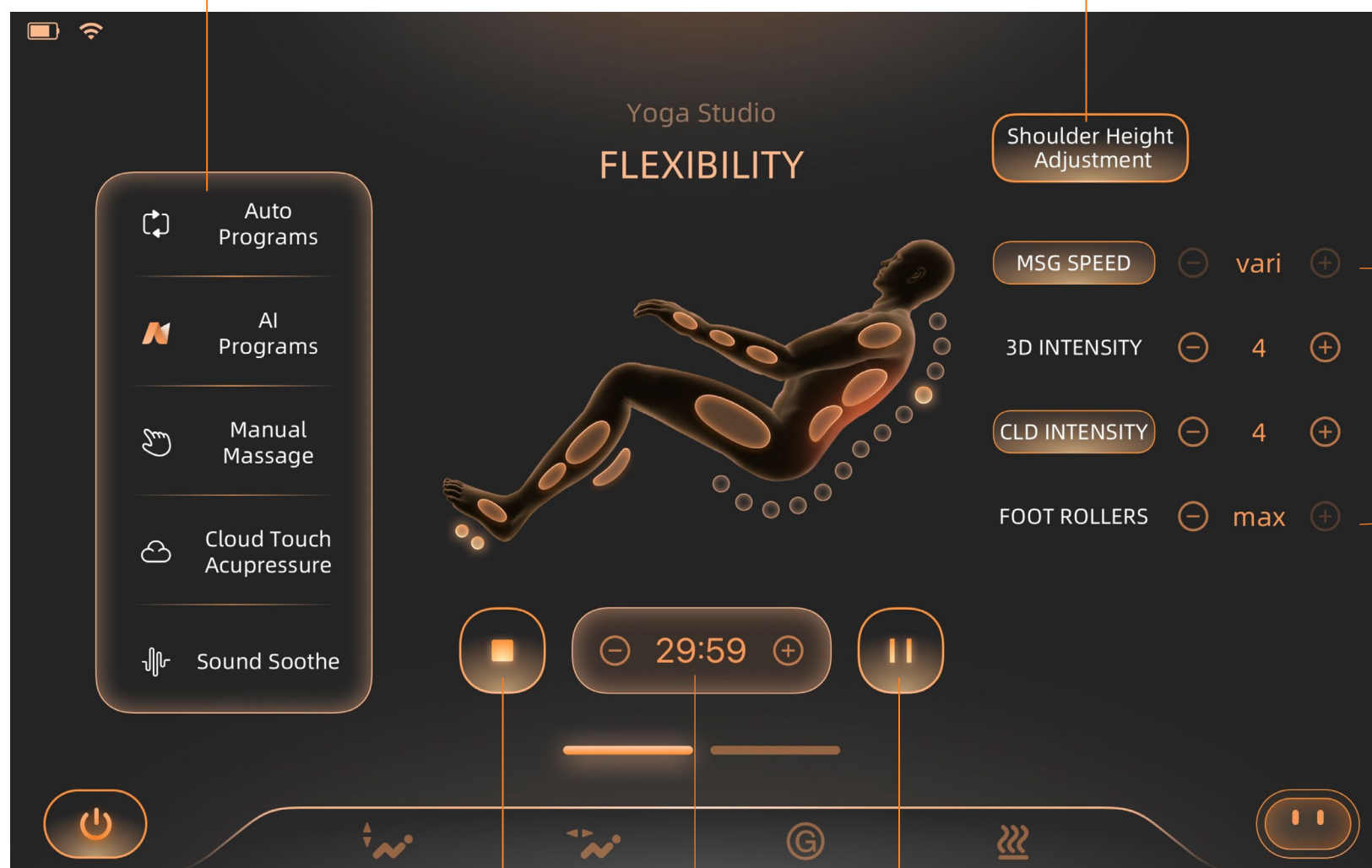

**Stop** the massage and restore the chair to an upright position

**Pause** the current massage.

Adjust the **Message Intensity**, **Cloud Touch Acupressure Intensity**, and **Foot Roller Speed**.

The time remaining on your massage. Increase or decrease **massage time** in 5-minute increments.

**Note:** Massage Speed and Air Intensity have additional adjustment options – see the CUSTOMIZE YOUR MASSAGE section.

## CUSTOMIZE YOUR MESSAGE

### MESSAGE SPEED CUSTOMIZATION

Take control over the massage speed shoulders, mid back, lower back, and hip & glute zones during Auto Programs, AI-generated programs, and Manual massages.

On the massage session screen, select the **MSG SPEED** button.

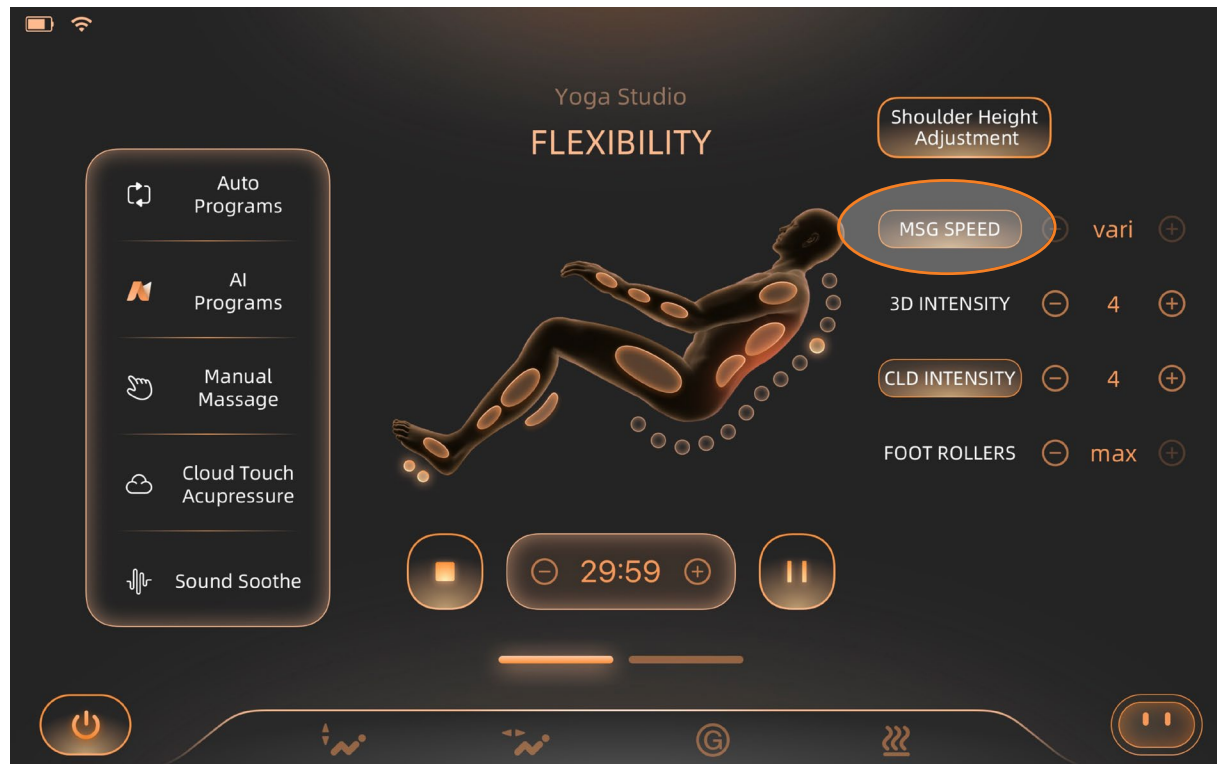

1. To adjust the speed in a specific zone, drag and release the slider to your desired speed.
2. To reset all speeds to the same setting, drag the FULL BODY slider to the preferred setting.

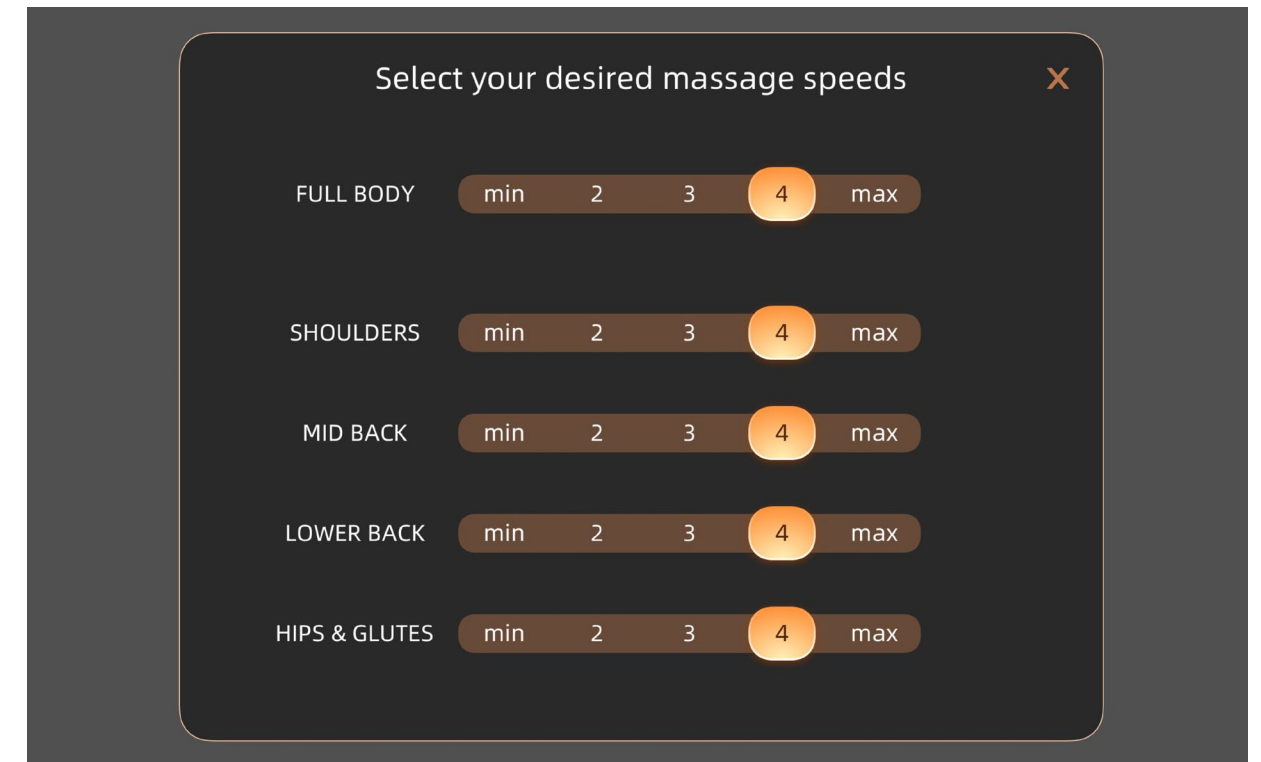

## CLOUD TOUCH ACUPRESSURE INTENSITY

Select one or more air compression zones, or a comprehensive FULL BODY session, and adjust the intensity of each zone during any massage session.

On the massage session screen, select the **CLD INTENSITY** button.



- Select FULL BODY for a comprehensive experience, or...
- Select an individual zone for precise recovery.
- To adjust the air compression intensity in specific areas, select each zone to activate, then drag and release the slider at your desired intensity level.

**Tip:** You can select as many zones as you prefer, setting individual intensity in each.

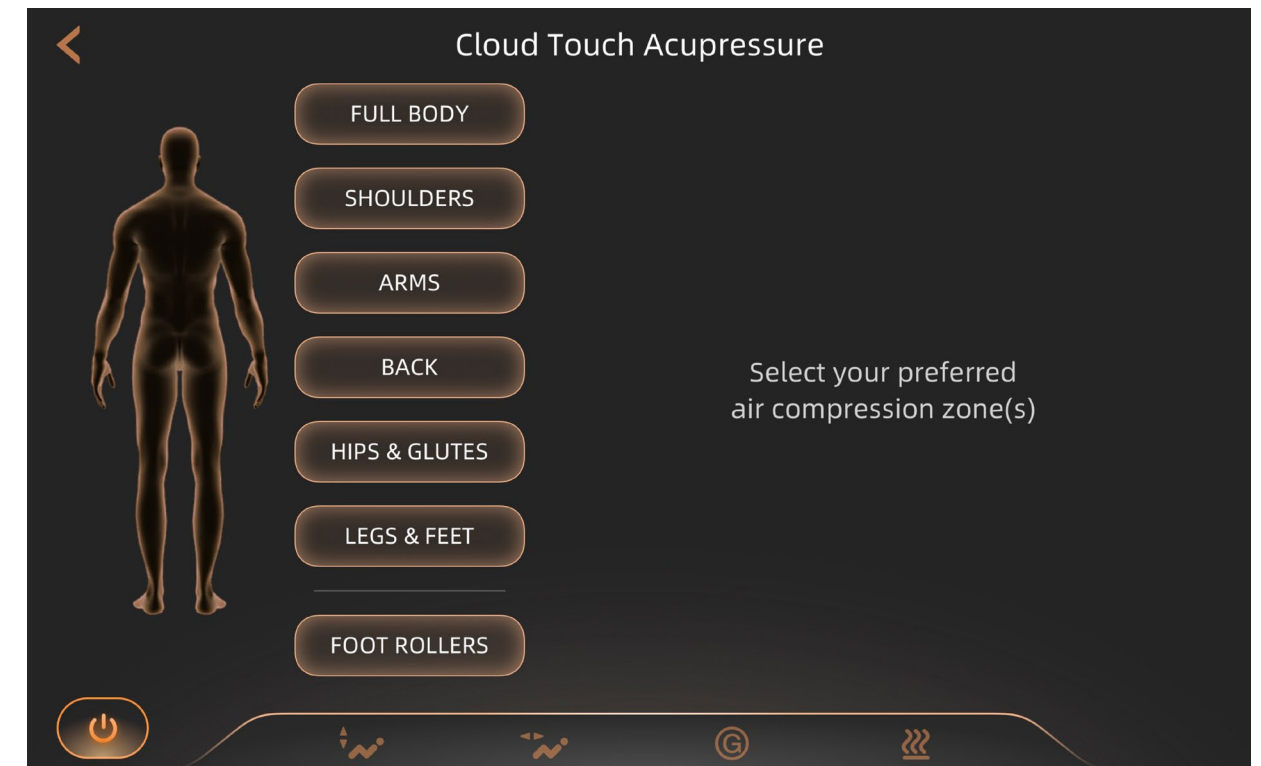

**NOTE:** When switching from zones to FULL BODY, adjust all zones to the same intensity level to activate the FULL BODY zone.

## USING MANUAL MESSAGE

Personalize your recovery by choosing the exact massage technique and focus area your body needs. These manual settings empower you to target specific muscle groups, allowing you to customize each setting for a truly professional, hand-tailored experience.

- To get started, select a specific **zone**, **FULL BODY**, or **SPOT**.
- Then, choose a massage **Technique**.

**NOTE:** When selecting a SPOT massage, press and hold the adjustment arrows to position the massage exactly where you need it.



TECHNIQUE	DESCRIPTION
<b>KNEADING</b>	Small, circular motion works both sides of the spine simultaneously
<b>KNEAD &amp; PERCUSS</b>	Combination of circular motion with rapid tapping
<b>PERCUSSION</b>	Rapid tapping strokes alternating along the spine for deep muscle therapy
<b>TAP TOUCH</b>	Rhythmic pulsing and rolling
<b>ROLLING</b>	Gentle glide along the spine
<b>3D SHIATSU</b>	Gentle glide with focused pressure applied at intervals along the spine to emulate traditional point work technique
<b>AUDIO SYNC</b>	When connected to your device, massage rhythm matches your music.

After selecting your Manual Massage **Technique** and **zone**, customize the **Width**, **Speed**, and **3D Intensity** to customize your experience.

**WIDTH** – Change how wide the massage is from Narrow to Wide.

**NOTE:** Width cannot be adjusted when using the Kneading, Knead & Percuss, or Audio Sync techniques

**SPEED** – Adjust how fast, or slow, the massage techniques massages you.

**NOTE:** Speed cannot be adjusted when using the Rolling, 3D Shiatsu, or Audio Sync techniques

**3D INTENSITY** – Choose the depth of your massage experience, from gentle (min) to deep (max).

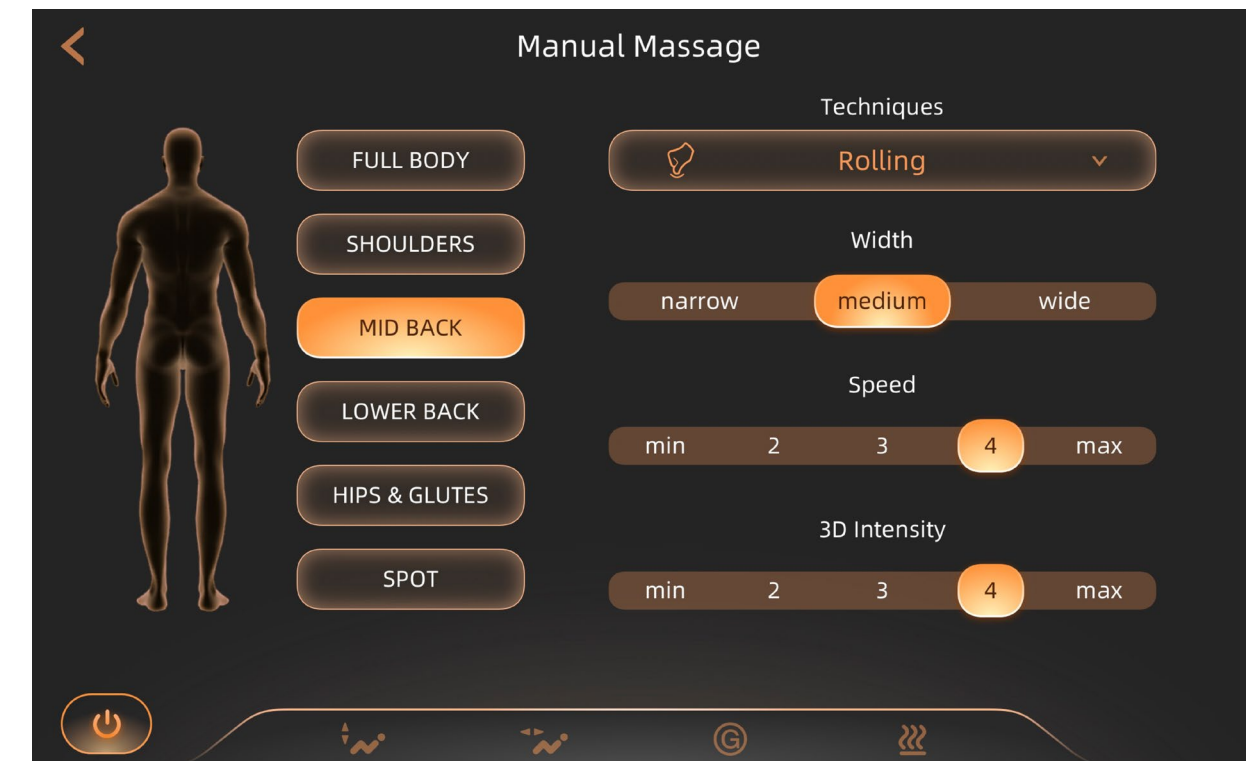

## USING SOUND SOOTHE

Transform your massage into a fully immersive sensory experience with Sound Soothe.

Choose from eight calming audio tracks designed to melt away stress, either as a peaceful standalone session or as the perfect rhythmic accompaniment to your recovery.

From the main menu, select **Sound Soothe**, then choose your audio experience.

Select the Sound track again to turn Sound Soothe OFF.

**NOTE:** Sound Soothe can be accessed from the Main Menu or the massage status screen.

To adjust the Volume, drag the slider up or down and release at your preferred level, or use the Volume buttons on the right-hand side of the tablet.





Your massage chair contains built-in, high-quality premium Sound by JBL speakers to which you can connect via Bluetooth. See **SETTINGS > BLUETOOTH AUDIO CONNECTION** for details on how to pair your device.

## SETTINGS

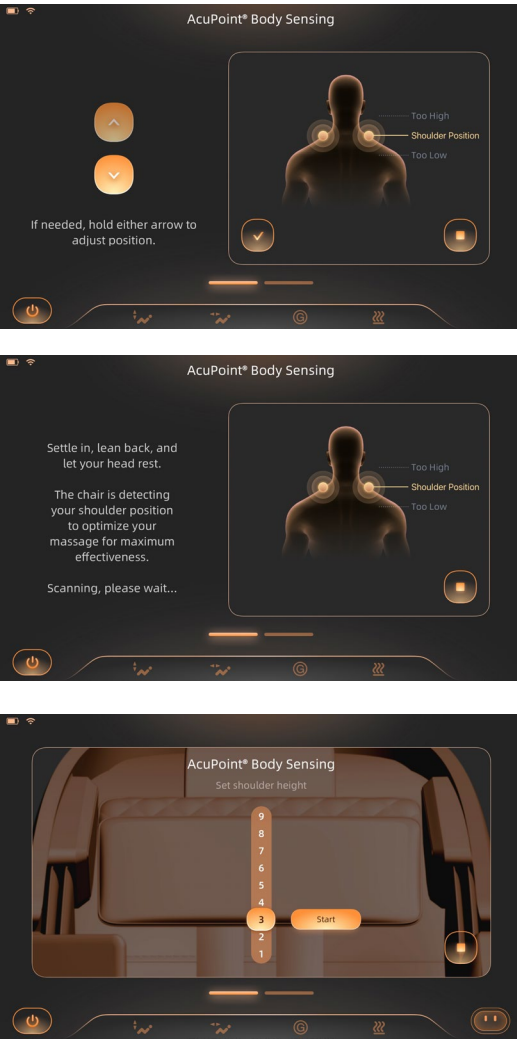
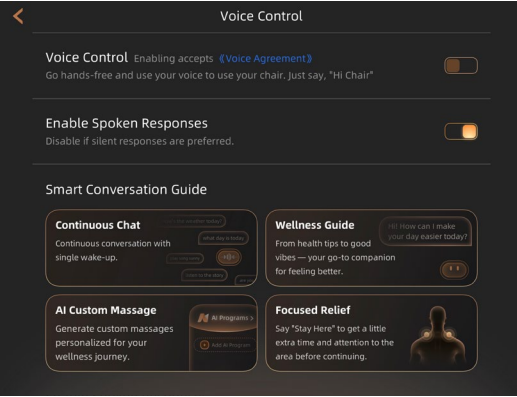
SETTING	DESCRIPTION
	<p><b>WI-FI</b></p> <p>Toggle Wi-Fi on or off, find and connect to your preferred Wi-Fi network.</p> <p><b>Note:</b> Press (i) icon to disconnect from Wi-Fi network.</p>
	<p><b>TABLET CONTROL CONNECTION</b></p> <p>Pair your tablet remote with your chair. Search for your chair's Serial Number (located on the backside of the chair) to pair remote.</p>
	<p><b>BLUETOOTH AUDIO CONNECTION</b></p> <p><b>Use Mobile Audio</b> – Make the chair Bluetooth discoverable to pair your mobile device, allowing you to play music and audio through the chair's speakers.</p> <p><b>Note:</b> Enabling this feature prevents voice prompts from being played through the built-in chair speakers—they are played through the tablet speakers instead.</p> <p><b>Activate Chair Audio</b> – Hide your chair Bluetooth to prevent devices connecting. Note: A currently connected device will not be disconnected if this option is selected.</p>
	<p><b>DEFAULT MESSAGE TIME</b></p> <p>Set the default message time for Auto, AI-generated, and Manual Massage programs to 10-, 20-, or 30-minute sessions.</p> <p><b>Note:</b> Message times can be adjusted in 5-minute increments in the massage session screen.</p>

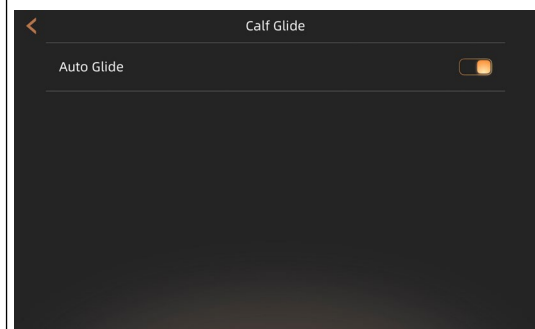
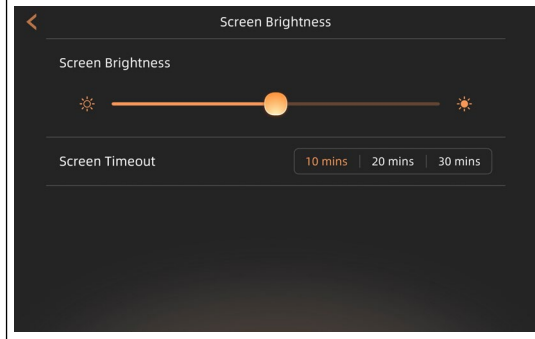
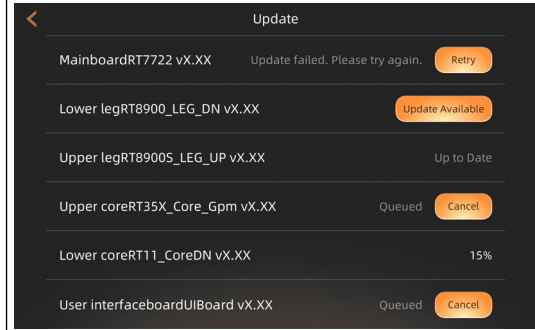
SETTING	DESCRIPTION
	<p>Select between two detection methods for identifying user shoulder height.</p> <p><b>Auto</b> – Uses AcuPoint® Body Sensing technology to locate the ideal massage position. When position is found, jump right in by pressing the check mark or fine-tune the position with the arrow keys.</p> <p><b>Manual</b> – Use the slider to select your preferred shoulder position.</p> <p><b>Note:</b> Shoulder height can be recalibrated or reset during any massage by pressing the <b>Shoulder Height Adjustment</b> option in the massage status screen.</p>
	<p>Enable voice control to access AI Programs and enjoy a fully hands-free experience.</p> <p><b>Note:</b> To use any voice or AI features, user must accept the <b>USE ACKNOWLEDGEMENT</b>.</p> <p><b>Enable Spoken Responses</b> – Enabling allows the chair to speak responses to your questions and input back to you. Disabling prevents this feature.</p>

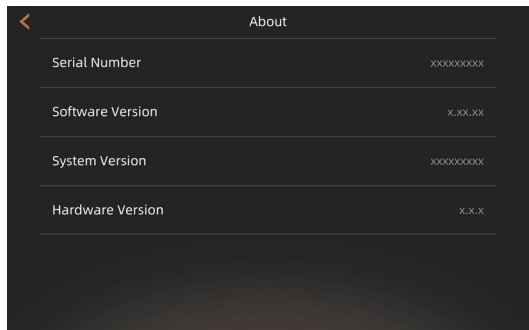
SETTING	DESCRIPTION
	<p>Select your preferred language between English or Chinese.</p>
	<p>Enable this feature to allow the calf massager to move up and down automatically during a massage.</p> <p><b>Note:</b> You can adjust the position of the calf massager in the <b>CALF FOCUS</b> option of the <b>Position Controls</b>.</p>
	<p>Choose how bright your tablet display is by dragging the slider left and right—left to make dimmer, right to brighten.</p> <p>You can also select how long your screen will stay on for when not in use. Choose from 10-, 20-, and 30-minute options.</p>
	<p>Stay current and view version numbers and update status for all chair components at a glance.</p> <p><b>Note:</b> Ensure your chair is connected to a Wi-Fi network to receive and download the latest software improvements.</p> <p><b>Tip:</b> You will receive an on-screen alert whenever a new update is ready for installation. If you dismiss that notification come to this screen to install your updates.</p>

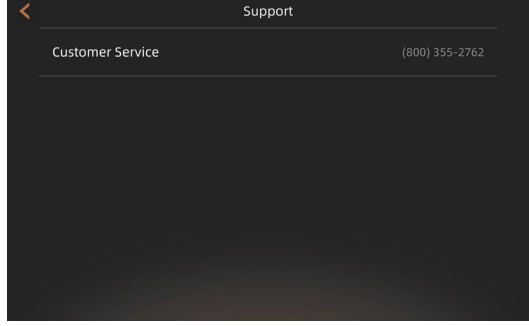
SETTING	DESCRIPTION
	<p><b>ABOUT</b></p> <p>This screen provides your unique tablet serial number and current system versions, serving as your go-to for technical details during support events or registration.</p> <p><b>Tip:</b> Use the manual check to find and install the newest tablet software enhancements.</p>
	<p><b>RESTORE TO FACTORY SETTINGS</b></p> <p>Reset your chair's software to its original state and clear all personal preferences. This option allows you to erase saved settings and return all chair configurations to their out-of-the-box defaults.</p> <p><b>Note:</b> Factory reset requires a Wi-Fi connection.</p>
	<p><b>SUPPORT</b></p> <p>Quickly find our customer service contact information to speak with a specialist or browse the complete Use and Care Guide for detailed instructions and tips.</p>

# want a stronger massage?

## Back massage to soft?

Flip the head pillow over the top of the backrest or unzip to remove it.

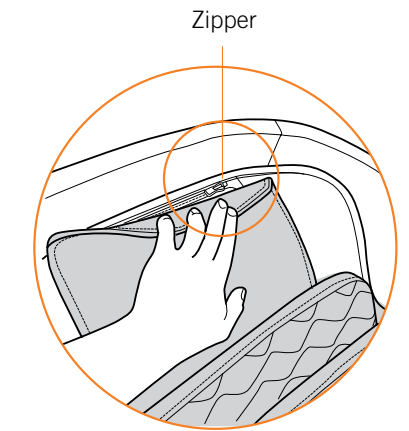
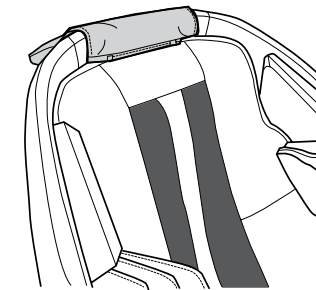
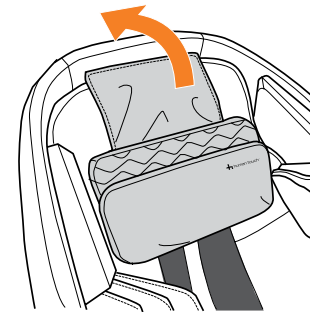

## Massage too strong?

Flip the head pillow down to use as a back softening pad, reducing the massage intensity.

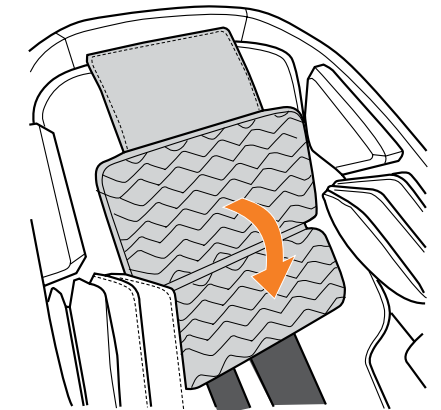

## Foot massage too soft?

Remove the softening soles from underneath your feet. Simply pull the softening soles from the pouches through the opening on the inside edge of the foot well.

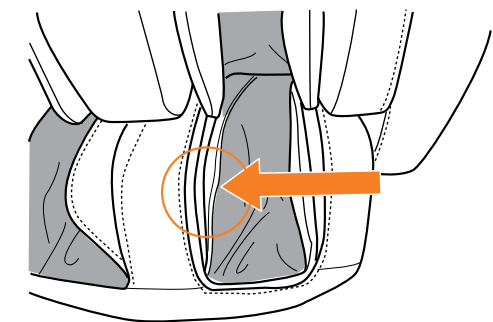

# care and maintenance

To keep your product working and looking its best, please follow these simple care guidelines.

## **WARNING:**

1. Be sure to disconnect the power cord from the electrical outlet before cleaning.
2. When cleaning the controller or power switch, use a dry cloth only. Never use a damp cloth to clean the controller or power switch.
3. Be sure to test any cleaning solution on a small, inconspicuous part of the product to ensure that the color does not fade prior to using the solution on the entire product surface.
4. Do not use benzene, thinner or any other solvents on your product.

### **Cleaning Code Standard: W**

To maintain your Human Touch product in optimum condition, dust it frequently and/or vacuum it with a soft brush vacuum extension. If your product becomes dirty, use a water-based upholstery cleaner only. To treat stains, spot clean with an upholstery shampoo or a mild detergent foam. To clean the foot/calf massage well inserts, remove the inserts from the chair, hand-wash with a mild detergent, then line dry.

### **Maintenance and Repair:**

1. The mechanics of this product are specially designed and constructed to be maintenance free. No periodic lubrication or servicing is required.
2. Your chair should only be serviced by an authorized service center.
3. Replace the four 9V batteries that power the battery backup system after each use or once a year if unused.

### **Use and Storage Environment:**

1. When not in use for a long period of time, we recommend that the chair be covered, the power cord be coiled and that the unit be placed in an environment free of dust and moisture.
2. Do not store near heat or open flame.
3. Do not leave this product exposed to direct sunlight for long periods of time. This may cause fading or damage.
4. Do not use or store in extreme temperatures; product stored in cold temperatures may require 48 hours at room temperature to function properly.
5. Product should be used and stored in an environment with non-condensing humidity ranging from 10 to 80%; excessive humidity will damage the mechanics.

### **Miscellaneous:**

1. Foreign objects should not be inserted between the massage nodes or the unit housing.
2. Care should be taken not to overload the unit.

# having trouble?

Your Super Novo 3.0 massage chair is a sophisticated combination of mechanics, electronics, and software working together to give you the ultimate massage. With such complexity comes opportunity for what we like to call massage chair “confusion.” So, should your massage chair exhibit any abnormal behavior, please do the following to fully reset the chair:

1. Press the **POWER / PAUSE / RESTORE** button on the remote, then select **POWER OFF** to restore the chair to the upright position.
2. Turn the chair's power switch (on the rear of the chair) to Off.
3. Unplug the chair from the power source.
4. Wait 30 seconds.
5. Plug the chair back into the power source, then turn the power switch back On.

If your chair has no power:

1. **Check the power cord** - Make sure the power cord connection to the chair is secure and that the power cord is not damaged.
2. **Check the wall outlet** - Plug a known working device into the outlet to ensure the outlet is working.
3. **Replace the fuse** - Use a flat-head screwdriver to turn the fuse holder (located next to the power switch) counter-clockwise until it pops out. Replace the fuse with one of the spare fuses that came with your chair, or any 250V, 5A fuse.

Just like with any other electronics, this simple reset sequence will resolve many issues. If, however, your issue remains, please do the following before contacting our customer experience team (this will help us help you much more quickly):

1. Locate the serial number on label on the back of your chair and write it down.
2. Locate your proof of purchase, as we will need it to process any warranty claim.
3. Write down the specific steps you took before experiencing the problem. For example: “I sat down in the chair, then I selected Cloud Touch on the remote, then I selected Foot/Calf, then I heard a loud noise that is not normal.”
4. Now you're ready to contact us!



Scan for Support

Having Trouble? Visit [support.humantouch.com](https://support.humantouch.com)  
or email [csadmin@humantouch.com](mailto:csadmin@humantouch.com) for assistance.

### **Specifications\***

Operating Voltage:	AC110-120V 60 Hz
Power Consumption:	1.35A
USB Port:	5V, 2A
Product Weight:	291 lb
Maximum Load Weight:	285 lb

*\*Specifications are subject to change without prior notice.*